

Card Reader

MoveData

microSD

Operating Instructions

GB

Bedienungsanleitung

D

Mode d'emploi

F

Instrucciones de uso

E

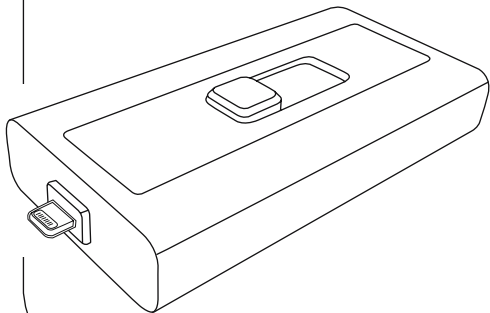

Thank you for choosing a Hama product.

Take your time and read the following instructions and information completely. Please keep these instructions in a safe place for future reference. If you sell the device, please pass these operating instructions on to the new owner.

1. Explanation of Warning Symbols and Notes



Warning

This symbol is used to indicate safety instructions or to draw your attention to specific hazards and risks.



Note

This symbol is used to indicate additional information or important notes.

2. Package Contents

- „MoveData“ Lightning-USB Card Reader
- These operating instructions

3. Safety Notes

- The product is intended for private, non-commercial use only.
- Protect the product from dirt, moisture and overheating and use it in dry rooms only.
- Do not use the product in the immediate vicinity of heaters or other heat sources or in direct sunlight.
- Do not drop the product and do not expose it to any major shocks.
- Do not attempt to service or repair the product yourself. Leave any and all service work to qualified experts.
- Do not open the device or continue to operate it if it becomes damaged.
- Dispose of packaging material immediately according to locally applicable regulations.
- Do not modify the product in any way. Doing so voids the warranty.
- Keep this product, as all electrical products, out of the reach of children!

4. Technical Data



Warning

Never use the USB type A and the Lightning plug at the same time.

	„MoveData“ Lightning-USB Card Reader
Power Supply	5V max. 500 mA
Memory Card	microSD/ microSDHC/ microSDXC
Connections	USB 2.0 type A Lightning (8-pin connector)
Operating Systems	<ul style="list-style-type: none">• Windows 10/8/7/Vista/XP• Mac OS 9.x or higher• iOS 5.1 or higher• Requirement: Installation of the Hama MoveData App

5. Using via USB Connector

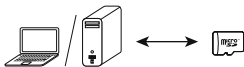

- Plug your memory card into the appropriate slot of the card reader.
- Press the unlocking device and push it into the direction of the desired connector (USB).
- Connect the card reader to a free USB port on your computer.
- You can now transfer data between your computer and the memory card.



Warning – Data Loss

- Ensure that the data transfer is done before you remove a memory card from your card reader.
- Always use the eject function of your operating system before you remove a memory card from your card reader or disconnect your card reader (with inserted memory card) from your end device.
- Data loss can't be excluded at disregard!

6. Using via Lightning Connector



Note – microSD/ microSDHC/ microSDXC memory cards

- The inserted memory card has to be formatted into FAT32 for an easy use.
- To transfer your data/files optimally the use of memory cards from class 10 is recommended.
- Download the Hama **MoveData** App from the Apple App Store.
- Plug your memory card into the appropriate slot of the card reader.
- Press the unlocking device and push it into the direction of the desired connector (Lightning).
- Connect the card reader with your terminal device (iPhone/iPad/iPod) via the lightning connector.
- Open the **MoveData** App.

There are several options for using the card reader in the main menu.



Contact Backup

- Backup of the contact information from the terminal device to the memory card
- Recovery of the contact information from the memory card to a terminal device



Local Storage

- Memory capacity for files directly in the Hama **MoveData** App
- Advantage: direct access to the stored data, even without card reader



External Storage

- Direct access to the files stored on the memory card (only when using the card reader)



Photo Album

- Direct access to the files (images and videos) on the terminal device



Settings

- Access to the settings section of the Hama **MoveData** App



Note – App Authorization

- For some functions, the Hama **MoveData** App needs the permission for access to your terminal device (e.g. contact information backup / recovery, back up images, etc.)
- If the app should have no permission, you get an appropriate notification while performing such a function.
- To permit the access, select the Hama **MoveData** App in the settings menu of the terminal device and push the appropriate switch to green.



Note – Icon



This icon is used when you have to touch the display on a certain spot to perform an action or open a menu.

6.1 Backup / Recovery of Contact Information



Warning – Data Loss when Restoring the Contact Information

If you restore contact information of the memory card on the terminal device, the contact information stored on the terminal device will be deleted. After restoring only the contact information of the backup file are available.

• → **Contact Backup**

• → **Backup**

All contact information of the terminal device will be backed up on the memory card of the card reader (in .vcf format).

• → **Restore**

Access to all contact information that are stored on the memory card. Select the file () that contains the desired contact information to restore them on the terminal device.

6.2 Data Transfer Between Local and External Storage

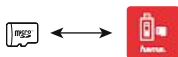

Note – Transferring Within the Same Memory Location

With this transfer method, files and folders can also be transferred within the same memory location (e.g. move an image from the external storage into a subfolder of the external storage).

6.2.1 Individual or Several Files/Folders

• → **Local Storage** or **External Storage**

Listing of all files and folders that are stored in the local (app) or the external storage (memory card).









• → **Edit**

Select the file(s) or folder(s) () that you want to transfer to the other storage. Three options are appearing on the lower display:

Delete: Deletes the selected file(s) or folder(s) from the local or external storage

Move: Moves the selected file(s) or folder(s) (deleting of the file(s) or folder(s) from the initial storage at the same time)











Copy: Copies the selected file(s) or folder(s) (preservation of the file(s) or folder(s) on the initial storage at the same time)

-  → **Copy or Move**
-  → **Local Storage** 
or **External Storage** 
Selected file(s) or folder(s) will be saved on the local (app) or external storage (memory card).
- You have several opportunities for saving the selected file(s) or folder(s):
 -  → **New Folder**
A new folder will be created. Enter a folder name and confirm **OK** ().
 -  → **Paste Here or Move to Here**
Selected file(s) or folder(s) will be saved into the selected folder or directly on the local/external storage.
The progress of the copy or move process is shown on the display.
-  → **Done**
The process will be completed.
-  → **Home**
Direct access to the main menu.

6.2.2 Individual Files

Note

With this transfer method, only individual files can be selected and transferred.

-  → **Local Storage** 
or **External Storage** 
Listing of all files and folders that are stored in the local (app) or the external storage (memory card).
-  → **Edit**
Select the file () that you want to transfer to the other storage.
-  → 
-  → **Copy or Move**
-  → **Local Storage** 
or **External Storage** 
The Selected file will be saved in the local (app) or external storage (memory card).

- You have several opportunities for saving the selected file:



→ **New Folder**

A new folder will be created. Enter a folder name and confirm with **OK** (hand cursor). Select the newly created or an already existing folder (hand cursor).



→ **Paste Here** or **Move to Here**

Selected file will be saved into the selected folder or directly on the local/external storage. The progress of the copy or move process is shown on the display.



→ **Done**

The process will be completed.



→ **Home**

Direct access to the main menu.

6.3 Data transfer from Local Storage to terminal device



Note

- You can transfer data from the local storage (app) to your terminal device or open/use it with other apps.
- With this transfer method, only individual images or videos can be transferred to your terminal device.



→ **Local Storage**

Listing of all files and folders that are stored in the local storage (app).



→ **Edit**

Select the file (hand cursor) that you want to transfer to the terminal device.



→



→ **Open In**



→ **Save Image** respectively **Save Video**

The selected image or video will be saved on the terminal device.



→ **Done**

The process will be completed.



→ **Home**

Direct access to the main menu.

6.4 Data transfer from the local/external storage to the terminal device

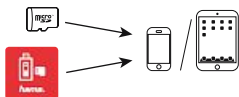



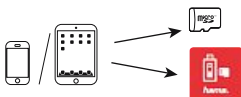



6.5 Data transfer from the terminal device to the local/external storage



Note









With this transfer method, only individual image files can be transferred to the terminal device.

-  → **Local Storage** 
or **External Storage** 
Listing of all files and folders that are stored in the local (app) or the external storage (memory card).
- Select the image () that you want to transfer to your terminal device.
- The image will be displayed.
-  → **Save**
The selected image will be saved on the terminal device.
-  → **Cancel**
-  → **Home**
Direct access to the main menu.

Note

With this transfer method, only image and video files can be transferred from the terminal device.

6.5.1 Via Photo Album

-  → **Photo Album** 
Listing of all media folders (albums) or files that are stored on the terminal device.
- If necessary choose the folder () that contains the desired file(s).
- Select the file(s) () that you want to transfer.
-  → **Done**
A target folder for saving the selected file(s) can be chosen.
-  → **Local Storage** 
or **External Storage** 
Selected file(s) will be saved in the local (app) or external storage (memory card)

- You have several opportunities for saving the selected file(s) or folder(s):



→ **New Folder**

A new folder will be created. Enter a folder name and confirm with **OK** (👉). Select the newly created or an already existing folder (👉).



→ **Paste To Here**

Selected file(s) will be saved into the selected folder or directly on the local/external storage. You reach the main menu automatically after finishing the copy process.

6.5.2 Via import from library



→ **Local Storage**

or **External Storage**

Listing of all files and folders that are stored in the local (app) or the external storage (memory card).



→ **+**



→ **From Library**

Listing of all media folders/files that are stored on the terminal device.

- If necessary choose the folder (👉) that contains the desired file(s).
- Select the file(s) (👉) that you want to transfer.



→ **Done**

The selected file(s) will directly be saved on the local/external storage. You are still in the listing of all files and folders that are stored on the local (app)/external storage (memory card).



→ **Home**







Direct access to the main menu.

6.5.3 Via Clipboard



Note

With this transfer method, only individual image files can be transferred from the terminal device

- Select in the gallery (Photos) of the terminal device the image (👉) that has to be transferred to the local/external storage. The image will be displayed.
-  → 
-  → **Copy**
The selected image will be copied into the clipboard of the terminal device.
- Open the Hama **MoveData** App
-  → **Local Storage** 
or **External Storage** 

Listing of all files and folders that are stored in the local (app) or the external storage (memory card).

-  → +

-  → **From Clipboard**

The selected image will directly be saved on the local/external storage. You are still in the listing of all files and folders that are stored on the local (app)/external storage (memory card).

-  → **Home**

Direct access to the main menu.

6.6 Delete files/folders from the local/external storage



6.6.1 Several files/folders

-  → **Local Storage** 

or **External Storage** 

Listing of all files and folders that are stored in the local (app) or the external storage (memory card).

-  → **Edit**

Select the file(s)/ folder(s) () that you want to delete.

-  → **Delete**

Confirm the deletion process (). The selected file(s)/ folder(s) will be deleted from the local/external storage.



-  → **Done**

You are still in the listing of all files and folders that are stored on the local (app)/external storage (memory card).

-  → **Home**

Direct access to the main menu.

6.6.2 Individual files

-  → **Local Storage** 

or **External Storage** 

Listing of all files and folders that are stored in the local (app) or the external storage (memory card).

-  → **Edit**

Select the file/folder () that you want to delete.

-  → 

-  → **Delete**

Confirm the deletion process (). The selected file/folder will be deleted from the local/external storage.

-  → **Done**



You are still in the listing of all files and folders that are stored on the local (app)/external storage (memory card).

-  → **Home**









Direct access to the main menu.

6.7 Rename files in the local/external storage





-  → **Local Storage** 
or **External Storage** 





Listing of all files and folders that are stored in the local (app) or the external storage (memory card).

-  → **Edit**
Select the file () that you want to rename.
-  → 
-  → **Rename**
You can now rename the file. Enter a new name and confirm with **OK** ()
-  → **Done**
You are still in the listing of all files and folders that are stored on the local (app)/external storage (memory card).
-  → **Home**
Direct access to the main menu.



6.8 Create a new folder on the local/external storage

-  → **Local Storage** 
or **External Storage** 



Listing of all files and folders that are stored in the local (app) or the external storage (memory card).



-  → **+**
-  → **New Folder**
A new folder will be created. Enter a folder name and confirm with **OK** ()
-  → **Home**
Direct access to the main menu.

6.9 Create text documents on the local/external storage

-  → **Local Storage** 
or **External Storage** 

Listing of all files and folders that are stored in the local (app) or the external storage (memory card).





-  → **+**
-  → **New Text Document**
A new text document will be created. Enter the desired text.

-  → **Save**
Enter a file name for the text document and confirm with **OK** (). The text document is saved.





-  → **Cancel**
You are still in the listing of all files and folders that are stored on the local (app)/ external storage (memory card).

-  → **Home**
Direct access to the main menu.

6.10 Information about the local and external storage

-  →  at **Local Storage** 
or **External Storage** 
The maximum and still available storage capacity of the respective storage is displayed.

6.11 App Settings

-  → **Settings** 
Access to the settings of the Hama **MoveData** App.
-  → **About**
Further information about the software (Version, publisher of the App, etc.)
-  → **Show hidden files**
By activation of this option, hidden files will be displayed in the app.

-  → **Modify file extension**
By activation of this option, file extensions will be visible and can be changed (with help of the function rename, see 6.7. Rename files in the local/external storage).



Warning – Modify file extension

Modifying file extensions may lead to the file being useless.

7. Warranty Disclaimer

Hama GmbH & Co. KG assumes no liability and provides no warranty for damage resulting from improper installation/mounting, improper use of the product or from failure to observe the operating instructions and/or safety notes.

8. Service and Support

Please contact Hama Product Consulting if you have any questions about this product.
Hotline: +49 9091 502-115 (German/English)
Further support information can be found here:
www.hama.com

Vielen Dank, dass Sie sich für ein Hama Produkt entschieden haben!
Nehmen Sie sich Zeit und lesen Sie die folgenden Anweisungen und Hinweise zunächst ganz durch.
Bewahren Sie diese Bedienungsanleitung anschließend an einem sicheren Ort auf, um bei Bedarf darin nachschlagen zu können. Sollten Sie das Gerät veräußern, geben Sie diese Bedienungsanleitung an den neuen Eigentümer weiter.

1. Erklärung von Warnsymbolen und Hinweisen



Warnung

Wird verwendet, um Sicherheitshinweise zu kennzeichnen oder um Aufmerksamkeit auf besondere Gefahren und Risiken zu lenken.



Hinweis

Wird verwendet, um zusätzlich Informationen oder wichtige Hinweise zu kennzeichnen.

2. Packungsinhalt

- Lightning-USB-Kartenleser „MoveData“
- Diese Bedienungsanleitung

3. Sicherheitshinweise

- Das Produkt ist für den privaten, nicht-gewerblichen Haushaltsgebrauch vorgesehen.
- Schützen Sie das Produkt vor Schmutz, Feuchtigkeit und Überhitzung und verwenden Sie es nur in trockenen Räumen.
- Betreiben Sie das Produkt nicht in unmittelbarer Nähe der Heizung, anderer Hitzequellen oder in direkter Sonneneinstrahlung.
- Lassen Sie das Produkt nicht fallen und setzen Sie es keinen heftigen Erschütterungen aus.
- Versuchen Sie nicht, das Produkt selbst zu warten oder zu reparieren. Überlassen Sie jegliche Wartungsarbeit dem zuständigen Fachpersonal.
- Öffnen Sie das Produkt nicht und betreiben Sie es bei Beschädigungen nicht weiter.
- Entsorgen Sie das Verpackungsmaterial sofort gemäß den örtlich gültigen Entsorgungsvorschriften.
- Nehmen Sie keine Veränderungen am Produkt vor. Dadurch verlieren sie jegliche Gewährleistungsansprüche.
- Dieses Produkt gehört, wie alle elektrischen Produkte, nicht in Kinderhände!

4. Technische Daten



Warnung

Verwenden Sie keinesfalls den USB Typ A und den Lightning Stecker gleichzeitig.



Lightning-USB-Kartenleser „MoveData“

Stromversorgung

5V  max. 500 mA

Speicherkarte

microSD/ microSDHC/ microSDXC

Anschlüsse

USB 2.0 Typ A
Lightning (8 Pin-Anschluss)

Betriebssysteme

- Windows 10/8/7/Vista/XP
- Mac OS 9.x oder neuere Versionen
- iOS 5.1 oder neuere Versionen
- Voraussetzung: Installation der Hama App **MoveData**

5. Verwendung via USB-Anschluss

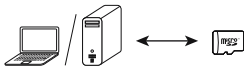

- Stecken Sie Ihre Speicherkarte in den entsprechenden Slot des Kartenlesers.
- Drücken Sie die Entriegelung und schieben Sie diese in die Richtung des gewünschten Anschlusses (USB).
- Schließen Sie den Kartenleser an einer freien USB Buchse Ihres Computers an.
- Sie können nun den Datentransfer zwischen Ihrem Computer und der Speicherkarte vornehmen.



Warnung – Datenverlust

- Bevor Sie eine Speicherkarte aus dem Kartenleser entnehmen, vergewissern Sie sich, dass der Datentransfer beendet ist.
- Entfernen Sie den Wechseldatenträger immer über die Auswurffunktion Ihres Betriebssystems, bevor Sie das Speichermedium aus dem Kartenleser entnehmen oder den Kartenleser (mit eingestecktem Speichermedium) von Ihrem Endgerät trennen.
- Bei Nichtbeachtung kann Datenverlust nicht ausgeschlossen werden!

6. Verwendung via Lightning Anschluss



Hinweis – microSD-/ microSDHC-/ microSDXC-Speicherkarten

- Um die eingesetzte Speicherkarte problemlos verwenden zu können, ist eine Formatierung in dem Dateiformat FAT32 notwendig.
- Für eine optimale Übertragung Ihrer Daten/ Dateien wird eine Verwendung von Speicherkarten ab Class10 empfohlen.
- Laden Sie die Hama App **MoveData** aus dem Apple App Store herunter.
- Stecken Sie Ihre Speicherkarte in den entsprechenden Slot des Kartenlesers.
- Drücken Sie die Entriegelung und schieben Sie diese in die Richtung des gewünschten Anschlusses (Lightning).
- Schließen Sie den Kartenleser mit Hilfe des Lightning-Anschlusses an Ihr Endgerät (iPhone/ iPad/iPod) an.
- Öffnen Sie die App **MoveData**.
Es stehen Ihnen im Hauptmenü verschiedene Menüs zur Nutzung des Kartenlesers zur Verfügung.



Kontakte Sichern

- Sicherung von Kontaktdaten des Endgerätes auf die Speicherkarte
- Wiederherstellung von Kontaktdaten der Speicherkarte auf einem Endgerät



Lokaler Speicher

- Speicherkapazität für Dateien direkt in der Hama App **MoveData**
- Vorteil: Direkter Zugriff auf hier gespeicherte Dateien, auch ohne Kartenleser



Externer Speicher

- Direkter Zugriff auf die Dateien der Speicherkarte (nur bei Verwendung des Kartenlesers)



Fotoalbum

- Direkter Zugriff auf die Dateien (Bilder, Videos) des Endgerätes



Einstellungen

- Zugriff auf die Einstellungen der Hama App **MoveData**



Hinweis – App Berechtigung

- Die Hama App **MoveData** benötigt für einige Funktionen die Berechtigung zum Zugriff auf Ihr Endgerät (z.B. Kontaktdaten sichern/ wiederherstellen, Bilder sichern, etc.)
- Sollte die App keine Berechtigung haben, erhalten Sie bei Ausführung einer solchen Funktion eine entsprechende Meldung.
- Um den Zugriff zu erlauben, wählen Sie die Hama App **MoveData** in den Einstellungen Ihres Endgerätes aus und schieben den entsprechenden Regler auf grün



Hinweis – Symbol



Dieses Symbol wird verwendet, wenn Sie den Bildschirm an einer bestimmten Stelle berühren müssen, um eine Aktion durchzuführen oder ein Menü zu öffnen.

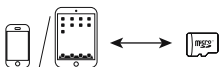

6.1 Sichern / Wiederherstellen von Kontaktdaten



Warnung – Datenverlust bei Wiederherstellung der Kontaktdaten

Wenn Sie Kontaktdaten von der Speicherkarte auf dem Endgerät wiederherstellen, werden die bereits auf dem Endgerät gespeicherten Kontaktdaten gelöscht. Nach Wiederherstellung stehen nur noch die Kontaktdaten aus der Sicherungsdatei zur Verfügung.

•  → **Kontakte Sichern** 

•  → **Sicherung** 

Alle Kontaktdaten des Endgerätes werden auf der Speicherkarte des Kartenlesers (im .vcf-Format) gesichert.

•  → **Wiederherstellung** 

Zugriff auf alle Kontaktdaten, die auf der Speicherkarte gespeichert sind.
Wählen Sie die Datei () , die die gewünschten Kontaktdaten enthält, aus, um diese auf dem Endgerät wiederherzustellen.

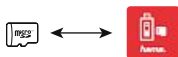

6.2 Datenübertragung zwischen lokalem und externen Speicher





Hinweis – Übertragung innerhalb desselben Speicherortes

Bei dieser Übertragungsvariante können auch Dateien und Ordner innerhalb desselben Speicherortes übertragen werden (z.B. ein Bild vom externen Speicher in einen Unterordner des externen Speichers verschieben).



6.2.1 Einzelne oder mehrere Dateien/ Ordner

•  → **Lokaler Speicher** 
oder **Externer Speicher** 

Auflistung aller auf dem lokalen (App) oder externen Speicher (Speicherkarte) gespeicherten Dateien und Ordner.

-  → **Bearbeiten**
Wählen Sie die Datei(en) oder Ordner aus () , die Sie auf den anderen Speicher übertragen möchten.
Am unteren Bildschirmrand erscheinen drei Auswahlmöglichkeiten:
Löschen: Löscht ausgewählte Datei(en) oder Ordner vom lokalen oder externen Speicher
Verschieben: Verschiebt ausgewählte Datei(en) oder Ordner (Gleichzeitiges Entfernen der Datei(en) oder Ordner vom ursprünglichen Speicher)
Kopieren: Kopiert ausgewählte Datei(en) oder Ordner (Gleichzeitiges Erhalten der Datei(en) oder Ordner auf ursprünglichen Speicher)

-  → **Kopieren** oder **Verschieben**

-  → **Lokaler Speicher** 
oder **Externer Speicher** 

Ausgewählte Datei(en) oder Ordner werden im lokalen (App) oder externen Speicher (Speicherkarte) gespeichert.

- Sie haben verschiedene Möglichkeiten, ausgewählte Datei(en) oder Ordner abzuspeichern:

-  → **Neuer Ordner**

Es wird ein neuer Ordner erstellt. Geben Sie einen Ordnernamen ein und bestätigen mit **OK** () .

Wählen Sie den neu erstellten oder einen bereits bestehenden Ordner aus () .

-  → **Hier einfügen** oder **Verschieben einfügen**
Ausgewählte Datei(en) oder Ordner werden in dem ausgewählten Ordner oder direkt auf dem lokalen/ externen Speicher abgespeichert.
Der Fortschritt des Kopier-/ Verschiebevorgangs wird auf dem Display angezeigt.





-  → **Fertig**
Der Vorgang wird abgeschlossen.







-  → **Home**
Direktzugang zum Hauptmenü.

6.2.2 Einzelne Dateien

Hinweis

Bei dieser Übertragungsvariante kann immer nur eine einzelne Datei ausgewählt und übertragen werden.

-  → **Lokaler Speicher** 
oder **Externer Speicher** 
Auflistung aller auf dem lokalen (App) oder externen Speicher (Speicherkarte) gespeicherten Dateien und Ordner.
-  → **Bearbeiten**
Wählen Sie die Datei aus () , die Sie auf den anderen Speicher übertragen möchten.

-  → 
-  → **Kopieren** oder **Verschieben**
-  → **Lokaler Speicher** 
oder **Externer Speicher** 

Die ausgewählte Datei wird im lokalen (App) oder externen Speicher (Speicherkarte) gespeichert.









- Sie haben verschiedene Möglichkeiten, die ausgewählte Datei abzuspeichern:
 -  → **Neuer Ordner**
Es wird ein neuer Ordner erstellt. Geben Sie einen Ordnernamen ein und bestätigen mit **OK** ().
Wählen Sie den neu erstellten oder einen bereits bestehenden Ordner aus ().
 -  → **Hier einfügen** oder **Verschieben einfügen**
Die ausgewählte Datei wird in dem ausgewählten Ordner oder direkt auf dem lokalen/ externen Speicher abgespeichert. Der Fortschritt des Kopier-/ Verschiebevorgangs wird auf dem Display angezeigt.
 -  → **Fertig**
Der Vorgang wird abgeschlossen.
 -  → **Home**
Direktzugang zum Hauptmenü.



6.3 Dateiübertragung vom lokalen Speicher zum Endgerät



Hinweis

- Vom lokalen Speicher (App) aus können die Dateien auf das Endgerät übertragen oder mit anderen Apps geöffnet/ verwendet werden.
- Bei dieser Dateiübertragung können ausschließlich Bild- und Video-Dateien (einzeln) auf das Endgerät übertragen werden.

-  → **Lokaler Speicher** 
Auflistung aller auf dem lokalen Speicher (App) gespeicherten Dateien und Ordner
-  → **Bearbeiten**
Wählen Sie die Datei aus (), die Sie auf das Endgerät übertragen möchten.
-  → 
-  → **Öffnen**
-  → **Bild sichern** bzw. **Video sichern**
Das ausgewählte Bild bzw. Video wird auf dem Endgerät gespeichert.



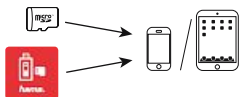

-  → **Fertig**
Der Vorgang wird abgeschlossen.
-  → **Home**
Direktzugang zum Hauptmenü.



6.4 Dateiübertragung vom lokalen/ externen Speicher zum Endgerät



Hinweis

Bei dieser Dateiübertragung können ausschließlich Bild-Dateien (einzeln) auf das Endgerät übertragen werden.

-  → **Lokaler Speicher** 
oder **Externer Speicher** 
Auflistung aller auf dem lokalen (App) oder externen Speicher (Speicherkarte) gespeicherten Dateien und Ordner.
- Wählen Sie das Bild aus () , das Sie auf das Endgerät übertragen möchten.
- Das Bild wird angezeigt.
-  → **Sichern**
Das ausgewählte Bild wird auf dem Endgerät gespeichert.

-  → **Abbrechen**
-  → **Home**
Direktzugang zum Hauptmenü.



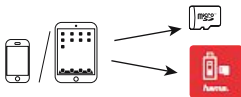

6.5 Dateiübertragung vom Endgerät zum lokalen/ externen Speicher



6.5.1 Via Fotoalbum



Hinweis

Bei dieser Dateiübertragung können ausschließlich Bild- und Video-Dateien vom Endgerät übertragen werden.

-  → **Fotoalbum** 
Auflistung aller auf dem Endgerät gespeicherten Medien-Ordner(Alben) oder Dateien.
- Ggfs. wählen Sie den Ordner aus () , in dem sich die gewünschte(n) Datei(en) befinden.
- Wählen Sie die Datei(en) aus () , die Sie übertragen möchten.
-  → **Fertig**
Es kann ein Zielordner zum Abspeichern der ausgewählten Datei(en) bestimmt werden.

-  → **Lokaler Speicher** 
oder **Externer Speicher** 
Ausgewählte Datei(en) werden im lokalen (App) oder externen Speicher (Speicherkarte) gespeichert.

- Sie haben verschiedene Möglichkeiten, ausgewählte Datei(en) oder Ordner abzuspeichern:

-  → **Neuer Ordner**
Es wird ein neuer Ordner erstellt. Geben Sie einen Ordernamen ein und bestätigen mit **OK** ().
Wählen Sie den neu erstellten oder einen bereits bestehenden Ordner aus ().



-  → **Hier einfügen**
Ausgewählte Datei(en) werden in dem ausgewählten Ordner oder direkt auf dem lokalen oder externen Speicher abgespeichert.
Nach Abschluss des Kopiervorgangs gelangen Sie automatisch in das Hauptmenü.

6.5.2 Via Importieren aus Galerie

-  → **Lokaler Speicher** 
oder **Externer Speicher** 
Auflistung aller auf dem lokalen (App) oder externen Speicher (Speicherkarte) gespeicherten Dateien und Ordner.

-  → **+**

-  → **Importieren aus Galerie**
Auflistung aller auf dem Endgerät gespeicherten Medien-Ordner/ Dateien.

- Ggfs. wählen Sie den Ordner aus (), in dem sich die gewünschte(n) Datei(en) befinden.
- Wählen Sie die Datei(en) aus (), die Sie übertragen möchten.



-  → **Fertig**
Die ausgewählte(n) Datei(en) werden direkt auf dem lokalen/ externen Speicher abgespeichert. Sie befinden sich weiterhin in der Auflistung aller auf dem lokalen (App)/ externen Speicher (Speicherkarte) gespeicherten Dateien und Ordner.

-  → **Home**
Direktzugang zum Hauptmenü.

6.5.3 Via Zwischenablage



Hinweis

Bei dieser Dateiübertragung können ausschließlich Bild-Dateien (einzeln) vom Endgerät übertragen werden

- Wählen Sie in der Galerie (Fotos) des Endgerätes das Bild aus (), das Sie auf den lokalen/ externen Speicher übertragen möchten. Das Bild wird angezeigt.
-  → 

-  → **Kopieren**
Das ausgewählte Bild wird in die Zwischenablage des Endgeräts kopiert.

- Öffnen Sie die Hama App **MoveData**.

-  → **Lokaler Speicher** 
oder **Externer Speicher** 

Auflistung aller auf dem lokalen (App) oder externen Speicher (Speicherkarte) gespeicherten Dateien und Ordner.

-  → **+**

-  → **Aus Zwischenablage einfügen**
Das ausgewählte Bild wird direkt auf dem lokalen/ externen Speicher abgespeichert. Sie befinden sich weiterhin in der Auflistung aller auf dem lokalen (App)/ externen Speicher (Speicherkarte) gespeicherten Dateien und Ordner.

-  → **Home**
Direktzugang zum Hauptmenü.



6.6 Löschen von Dateien/ Ordnern auf lokalem/ externem Speicher





6.6.1 Mehrere Dateien/ Ordner

-  → **Lokaler Speicher** 
oder **Externer Speicher** 
Auflistung aller auf dem lokalen (App) oder externen Speicher (Speicherkarte) gespeicherten Dateien und Ordner.

-  → **Bearbeiten**
Wählen Sie die Datei(en)/ Ordner aus () , die Sie löschen möchten.









-  → **Löschen**
Bestätigen Sie den Löschvorgang () . Die ausgewählte(n) Datei(en)/ Ordner werden vom lokalen/ externen Speicher entfernt.

-  → **Fertig**
Sie befinden sich weiterhin in der Auflistung aller auf dem lokalen (App)/ externen Speicher (Speicherkarte) gespeicherten Dateien und Ordner.

-  → **Home**
Direktzugang zum Hauptmenü.

6.6.2 Einzelne Dateien









-  → **Lokaler Speicher** 
oder **Externer Speicher** 
Auflistung aller auf dem lokalen (App) oder externen Speicher (Speicherkarte) gespeicherten Dateien und Ordner.

-  → **Bearbeiten**
Wählen Sie die Datei/ den Ordner aus () , die/ den Sie löschen möchten.
-  → 
-  → **Löschen**
Bestätigen Sie den Löschvorgang () .
Ausgewählte Datei/ Ordner wird vom lokalen/ externen Speicher entfernt.
-  → **Fertig**
Sie befinden sich weiterhin in der Auflistung aller auf dem lokalen (App)/ externen Speicher (Speicherkarte) gespeicherten Dateien und Ordner.
-  → **Home**
Direktzugang zum Hauptmenü.





6.7 Umbenennen von Dateien auf lokalem/ externem Speicher





-  → **Lokaler Speicher** 
oder **Externer Speicher** 
Auflistung aller auf dem lokalen (App) oder externen Speicher (Speicherkarte) gespeicherten Dateien und Ordner.









-  → **Bearbeiten**
Wählen Sie die Datei aus () , die Sie umbenennen möchten.
-  → 
-  → **Umbenennen**
Die Datei kann umbenannt werden. Geben Sie einen neuen Namen ein und bestätigen mit **OK** () .
-  → **Fertig**
Sie befinden sich weiterhin in der Auflistung aller auf dem lokalen (App)/ externen Speicher (Speicherkarte) gespeicherten Dateien und Ordner.
-  → **Home**
Direktzugang zum Hauptmenü.

6.8 Erstellen von neuem Ordner auf lokalem/ externem Speicher



-  → **Lokaler Speicher** 
oder **Externer Speicher** 
Auflistung aller auf dem lokalen (App) oder externen Speicher (Speicherkarte) gespeicherten Dateien und Ordner.
-  → **+**

-  → **Neuer Ordner**
Es wird ein neuer Ordner erstellt. Geben Sie einen Ordnernamen ein und bestätigen mit **OK** ()
-  → **Home**
Direktzugang zum Hauptmenü.





6.9 Erstellen von Textdokumenten auf lokalem/ externem Speicher

-  → **Lokaler Speicher** 
oder **Externer Speicher** 
Auflistung aller auf dem lokalen (App) oder externen Speicher (Speicherkarte) gespeicherten Dateien und Ordner.
-  → **+**
-  → **Neues Textdokument**
Es wird ein neues Textdokument erstellt. Geben Sie den gewünschten Text ein.
-  → **Sichern**
Geben Sie einen Dateinamen für das Textdokument ein und bestätigen mit **OK** () . Das Textdokument ist gespeichert.
-  → **Abbrechen**
Sie befinden sich weiterhin in der Auflistung aller auf dem lokalen (App)/ externen Speicher (Speicherkarte) gespeicherten Dateien und Ordner.
-  → **Home**
Direktzugang zum Hauptmenü.

6.10 Informationen über externen und lokalen Speicher

-  → **i Lokaler Speicher** 
oder **Externer Speicher** 
Ihnen werden die maximale sowie die noch verfügbare Speicherkapazität des jeweiligen Speichers angezeigt.

6.11 App Einstellungen

-  → **Einstellungen** 
Zugriff auf die Einstellungen der Hama App **MoveData**.
-  → **Über**
Nähere Informationen über die Software (Version, Herausgeber der App, etc.)
-  → **Ausgeblendete Dateien anzeigen**
Durch Aktivieren dieser Option werden ausgeblendete und versteckte Dateien über die App angezeigt.

-
-  → **Dateierweiterung ändern**
Durch Aktivieren dieser Option werden Dateierweiterungen sichtbar und können geändert werden (mithilfe der Funktion Umbenennen von 6.7 Umbenennen von Dateien auf lokalem/ externem Speicher).



Warnung

Das Abändern von Dateierweiterungen kann unter Umständen dazu führen, dass die Datei unbrauchbar wird.

7. Haftungsausschluss

Die Hama GmbH & Co. KG übernimmt keinerlei Haftung oder Gewährleistung für Schäden, die aus unsachgemäßer Installation, Montage und unsachgemäßem Gebrauch des Produktes oder einer Nichtbeachtung der Bedienungsanleitung und/oder der Sicherheitshinweise resultieren.

8. Service und Support

Bitte wenden Sie sich bei Fragen zum Produkt gerne an die Hama-Produktberatung.

Hotline: +49 9091 502-115 (Deu/Eng)

Weitere Supportinformationen finden sie hier:
www.hama.com

Nous vous remercions d'avoir choisi un produit Hama.

Veuillez prendre le temps de lire l'ensemble des remarques et consignes suivantes. Veuillez conserver ce mode d'emploi à portée de main afin de pouvoir le consulter en cas de besoin. Transmettez-le au nouveau propriétaire avec l'appareil le cas échéant.

1. Explication des symboles d'avertissement et des remarques



Avertissement

Ce symbole est utilisé pour indiquer des consignes de sécurité ou pour attirer votre attention sur des dangers et risques particuliers.



Remarque

Ce symbole est utilisé pour indiquer des informations supplémentaires ou des remarques importantes.

2. Contenu de l'emballage

- Lecteur de cartes Lightning - USB „MoveData“
- Mode d'emploi

3. Consignes de sécurité

- Ce produit est destiné à une installation domestique non commerciale.
- Protégez le produit de toute saleté, humidité, surchauffe et utilisez-le uniquement dans des locaux secs.
- N'utilisez pas le produit à proximité immédiate d'un chauffage, d'autres sources de chaleur ou exposé aux rayons directs du soleil.
- Protégez le produit des secousses violentes et évitez tout choc ou toute chute.
- Ne tentez pas de réparer l'appareil vous-même ni d'effectuer des travaux d'entretien. Déléguez tous travaux d'entretien à des techniciens qualifiés.
- Ne tentez pas d'ouvrir le produit en cas de détérioration et cessez de l'utiliser.
- Recyclez les matériaux d'emballage conformément aux prescriptions locales en vigueur.
- N'apportez aucune modification à l'appareil. Des modifications vous feraient perdre vos droits de garantie.
- Cet appareil, comme tout appareil électrique, doit être gardé hors de portée des enfants !

4. Caractéristiques techniques



Avertissement

N'utilisez en aucun cas simultanément le connecteur USB A et le connecteur Lightning.



Lecteur de cartes Lightning – USB „MoveData“

Alimentation en électricité	5V \equiv 500 mA maxi
Carte mémoire	microSD/ microSDHC/ microSDXC
Connexions	USB 2.0 A Lightning (8 broches)
Systèmes d'exploitation	<ul style="list-style-type: none">• Windows 10/8/7/Vista/XP• Mac OS 9.x ou versions ultérieures• iOS 5.1 ou versions ultérieures• Condition préalable : installation de l'application MoveData de Hama

5. Utilisation via une connexion USB

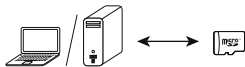

- Insérez votre carte mémoire dans l'emplacement correspondant du lecteur de cartes.
- Appuyez sur le verrouillage, puis faites-le glisser dans la direction du type de connexion souhaité (USB).
- Connectez le lecteur de cartes USB à un port USB libre de votre ordinateur.
- Vous pouvez alors lancer le transfert de données entre votre ordinateur et la carte mémoire.



Avertissement concernant la perte de données

- Assurez-vous que le transfert des données est terminé avant d'extraire la carte mémoire du lecteur.
- Retirez en tous les cas le disque amovible à l'aide de la fonction d'extraction de votre système d'exploitation avant d'extraire le périphérique de stockage du lecteur de cartes ou avant de déconnecter le lecteur (contenant un périphérique de stockage) de votre appareil.
- Vous risquez sinon de perdre des données.

6. Utilisation via une connexion Lightning



Remarque concernant les cartes mémoire microSD / microSDHC / microSDXC

- Un formatage en FAT32 est nécessaire pour obtenir un parfait fonctionnement de la carte mémoire utilisée.
 - Nous recommandons d'utiliser des cartes mémoire à partir de la classe 10 afin d'obtenir un transfert parfait de votre fichier / vos fichiers.
 - Veuillez télécharger l'application **MoveData** de Hama dans l'App Store d'Apple.
 - Insérez votre carte mémoire dans l'emplacement concerné du lecteur de cartes.
 - Appuyez sur le verrouillage, puis faites-le glisser dans la direction du type de connexion souhaité (Lightning).
 - Branchez le lecteur de cartes à votre appareil (iPhone/iPad/iPod) à l'aide de la connexion Lightning.
 - Ouvrez l'application **MoveData**.
- Différents sous-menus d'utilisation du lecteur de cartes sont disponibles dans le menu principal.



Sauvegarder les contacts

- Sauvegarde des contacts de l'appareil sur la carte mémoire
- Récupération des données de contacts de la carte mémoire sur un appareil externe



Mémoire locale

- Mémoire locale pour données sauvegardées directement sur l'application **MoveData** de Hama

- Avantage : accès direct aux données sauvegardées, même sans lecteur de cartes



Mémoire externe

- Accès direct aux données de la carte mémoire (uniquement lorsque vous utilisez le lecteur de cartes)



Album photo

- Accès direct aux fichiers (photos, vidéos) sauvegardés sur l'appareil externe



Paramètres

- Accès aux paramètres de l'application **MoveData** de Hama



Remarque concernant l'autorisation d'utilisation de l'application

- L'application **MoveData** de Hama requiert, pour certaines fonctions (sauvegarde/récupération des données de contacts, sauvegarde des photos, etc.), une autorisation d'accès à votre appareil externe
- Dans le cas où l'application ne dispose pas de cette autorisation, vous recevez un message correspondant lors de l'exécution de ces fonctions.
- Pour autoriser l'accès, sélectionnez l'application **MoveData** de Hama dans les paramètres de votre appareil externe, puis faites glisser le sélecteur sur la barre verte.



Remarque concernant l'icône



Cette icône apparaît lorsque vous devez effleurer une certaine zone de l'écran afin d'exécuter une action ou ouvrir un menu.

6.1 Sauvegarde / récupération des données de contacts

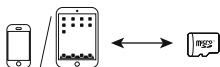

Avertissement concernant la perte de données lors de la récupération des données de contacts

Toutes les données de contacts sauvegardées sur un appareil externe seront écrasées pendant la récupération de données de contacts sur l'appareil à partir de la carte mémoire. Une fois la récupération terminée, seules les données de contacts provenant du fichier de sauvegarde seront disponibles.

• → Sauvegarde des contacts

• → Sauvegarde

Toutes les données de contacts seront sauvegardées sur la carte mémoire du lecteur de cartes (au format .vcf).

• → Récupération

Accès à toutes les données de contacts sauvegardées sur la carte mémoire. Sélectionnez le fichier () contenant les données de contacts que vous désirez utiliser afin de les récupérer sur votre appareil externe.

6.2 Transfert de données entre une mémoire locale et une mémoire externe

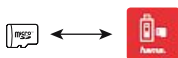



Remarque concernant le transfert dans un même emplacement de mémoire

Pour ce type de transfert, vous pouvez transférer des fichiers et des dossiers dans un même emplacement de mémoire (transfert d'une photo d'une mémoire externe vers un sous-dossier de la mémoire externe, etc.).



6.2.1 Un seul ou plusieurs fichier(s) / dossier(s)

• → Mémoire locale
ou mémoire externe

Liste de tous les fichiers ou dossiers sauvegardés dans la mémoire locale (application) ou externe (carte mémoire).



-  → **Edition**
Sélectionnez le/les fichier(s) ou le/les dossiers(s) () que vous désirez transférer sur une autre mémoire. Trois types de sélections apparaissent dans la partie inférieure de l'écran :
Effacement : Permet de l'effacement le/les fichier(s) ou le/les dossiers(s) sélectionnés de la mémoire locale ou externe.
Déplacer : permet de déplacer le/les fichier(s) ou le/les dossiers(s) sélectionnés (tout en supprimant le/les fichier(s) ou le/les dossiers(s) de la mémoire d'origine)
Copie : Permet de copier le/les fichier(s) ou le/les dossiers(s) sélectionnés (tout en conservant le/les fichier(s) ou le/les dossiers(s) dans la mémoire d'origine)



-  → **Copie ou déplacer**

-  → **Mémoire locale** 
ou **mémoire externe** 

Le/les fichier(s) ou le/les dossiers(s) sélectionnés seront sauvegardés dans la mémoire locale (application) ou la mémoire externe (carte mémoire).

- Vous disposez de différentes options pour sauvegarder le/les fichier(s) ou le/les dossiers(s) sélectionnés :







-  → **Nouveau dossier**
Un nouveau dossier sera créé. Saisissez le nom d'un dossier et confirmez votre sélection à l'aide de la touche **OK** ()
Sélectionnez le dossier que vous venez de créer ou un dossier existant ()

-  → **Insérez ou déplacez dans ce dossier**
Un/des fichier(s) ou un/des dossiers(s) seront sauvegardés dans le dossier sélectionné ou directement dans la mémoire locale ou la mémoire externe. La progression de la procédure de copie/de déplacer apparaît à l'écran.
-  → **Terminé**
La procédure est terminée.
-  → **Home**
Retour direct au menu principal.



6.2.2 Un seul fichier

Remarque

Pour ce type de transfert, vous ne pouvez sélectionner et transférer qu'un seul fichier.



-  → **Mémoire locale** 
ou **mémoire externe** 
Liste de tous les fichiers ou dossiers sauvegardés dans la mémoire locale (application) ou externe (carte mémoire).
-  → **Edition**
Sélectionnez le fichier () que vous désirez transférer sur une autre mémoire.
-  → 

•  → **Copie ou déplacer**

•  → **Mémoire locale** 
ou **mémoire externe** 

Le fichier sélectionné sera sauvegardé dans la mémoire locale (application) ou la mémoire externe (carte mémoire).

• Vous disposez de différentes options pour sauvegarder le fichier sélectionné :

 → **Nouveau dossier**
Un nouveau dossier sera créé. Saisissez le nom d'un dossier, puis confirmez votre sélection à l'aide de la touche **OK** (). Sélectionnez le dossier que vous venez de créer ou un dossier existant (.

•  → **Insérez ou déplacez dans ce dossier**
Le fichier sélectionné sera sauvegardé dans le dossier sélectionné ou directement dans la mémoire locale / externe.
La progression de la procédure de copie/de déplacer apparaît à l'écran.

•  → **Terminé**
La procédure est terminée.



•  → **Home**
Retour direct au menu principal.



6.3 Transfert de données vers un appareil externe depuis la mémoire locale





Remarque

- Vous pouvez transférer des fichiers sur un appareil externe depuis la mémoire locale (application) ou les ouvrir/les utiliser à l'aide d'autres applications.
- Dans ce type de transfert, vous ne pouvez transférer que des fichiers photo ou vidéo (individuels) vers un appareil externe.

•  → **Mémoire locale** 
Liste de tous les fichiers et dossiers sauvegardés dans la mémoire locale (application)

•  → **Edition**
Sélectionnez le fichier () que vous désirez transférer sur un appareil externe.

•  → 

•  → **Ouverture**

•  → **Sauvegarde de la photo ou du clip vidéo**
La photo /vidéo sera transférée sur l'appareil externe.

-  → **Terminé**
La procédure est terminée.

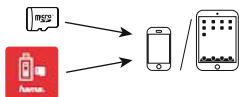

-  → **Home**
Retour direct au menu principal.

6.4 Transfert de données vers un appareil externe depuis la mémoire locale / externe



Remarque

Dans ce type de transfert, vous ne pouvez transférer que des fichiers photo (individuels) vers un appareil externe.

-  → **Mémoire locale** 
ou **mémoire externe** 
Liste de tous les fichiers et dossiers sauvegardés dans la mémoire locale (application) ou externe (carte mémoire).

- Sélectionnez la photo () que vous désirez transférer sur un appareil externe.

- La photo apparaît à l'écran.

-  → **Sauvegarde**
La photo sélectionnée sera transférée sur

l'appareil externe.

-  → **Interruption**

-  → **Home**
Direktzugang zum Hauptmenü.

6.5 Transfert de données vers la mémoire locale / externe depuis un appareil externe

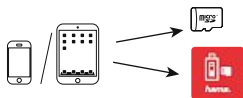

6.5.1 Via l'album photo





Remarque

Dans ce type de transfert, vous ne pouvez transférer que des fichiers photo ou vidéo à partir de l'appareil externe.

-  → **Album photo** 



Liste de tous les dossiers de médias (albums) ou fichiers sauvegardés dans l'appareil externe.

- Sélectionnez le dossier () contenant le/les fichier(s) que vous désirez utiliser.

- Sélectionnez le/les fichier(s) () que vous désirez transférer.



-  → **Terminé**
Vous pouvez définir un dossier-cible pour

sauvegarder le/les fichier(s) sélectionné(s).

-  → **Mémoire locale** 
ou **mémoire externe** 



Le/les fichier(s) sélectionnés seront sauvegardés dans la mémoire locale (application) ou la mémoire externe (carte mémoire).

- Vous disposez de différentes options pour sauvegarder le/les fichier(s) sélectionné(s) :

-  → **Nouveau dossier**
Un nouveau dossier sera créé. Saisissez le nom d'un dossier, puis confirmez votre sélection à l'aide de la touche **OK** (). Sélectionnez le dossier que vous venez de créer ou un dossier existant (.

-  → **Insérez dans ce dossier**
Le/les fichier(s) sélectionné(s) sera/seront sauvegardé(s) dans le dossier sélectionné ou directement dans la mémoire locale ou externe.
Vous retournerez automatiquement au menu principal une fois la procédure de copie terminée.



6.5.2 Via importation à partir de la galerie

-  → **Mémoire locale** 
ou **mémoire externe** 

Liste de tous les fichiers ou dossiers sauvegardés dans la mémoire locale (application) ou externe (carte mémoire).

-  → **+**

-  → **Importation à partir de la galerie**
Liste de tous les dossiers de médias (albums) ou fichiers sauvegardés dans l'appareil externe.

- Sélectionnez le dossier () contenant le/les fichier(s) que vous désirez utiliser.
- Sélectionnez le/les fichier(s) () que vous désirez transférer.

-  → **Terminé**
Le/les fichier(s) sélectionné(s) seront sauvegardés directement dans la mémoire locale / externe. La liste de tous les fichiers et dossiers sauvegardés dans la mémoire locale (application) ou externe (carte mémoire) reste affichée.









-  → **Home**
Retour direct au menu principal.

6.5.3 Via le cache

Remarque

Dans ce type de transfert, vous ne pouvez transférer que des fichiers photo (individuels) depuis un appareil externe.









- Sélectionnez, dans la galerie (photos) de l'appareil externe, la photo () que vous désirez transférer vers la mémoire locale / externe. La photo apparaît à l'écran.

-  → 
-  → **Copie**
La photo sélectionnée sera copiée dans le cache de l'appareil externe.
- Ouvrez l'application **MoveData** de Hama.
-  → **Mémoire locale** 
ou **mémoire externe** 
Liste de tous les fichiers ou dossiers sauvegardés dans la mémoire locale (application) ou externe (carte mémoire).
-  → **+**
-  → **Coller à partir du presse-papiers**
la photo sélectionnée sera directement sauvegardée sur la mémoire locale / externe. La liste de tous les fichiers et dossiers sauvegardés dans la mémoire locale (application) ou externe (carte mémoire) reste affichée.
-  → **Home**
Retour direct au menu principal.

6.6 Suppression de fichiers / dossiers sur la mémoire locale / externe











6.6.1 Plusieurs fichiers / dossiers

-  → **Mémoire locale** 
ou **mémoire externe** 
Liste de tous les fichiers ou dossiers sauvegardés dans la mémoire locale (application) ou externe (carte mémoire).
-  → **Edition**
Sélectionnez le/les fichier(s) / dossier(s) () que vous désirez Effacement.
-  → **Suppression**
Confirmez la procédure de suppression () . Le/les fichier(s) / dossier(s) seront supprimé(s) de la mémoire locale /externe.
-  → **Terminé**
La liste de tous les fichiers et dossiers sauvegardés dans la mémoire locale (application) ou externe (carte mémoire) reste affichée.
-  → **Home**
Retour direct au menu principal.

6.6.2 Un seul fichier









-  → **Mémoire locale** 
ou **mémoire externe** 
Liste de tous les fichiers ou dossiers sauvegardés dans la mémoire locale (application) ou externe (carte mémoire).

-  → **Edition**
Sélectionnez le fichier / le dossier () que vous désirez Effacement.
-  → 
-  → **Suppression**
Confirmez la procédure de suppression ()
Le fichier / dossier sera supprimé de la mémoire locale /externe.
-  → **Terminé**
La liste de tous les fichiers et dossiers sauvegardés dans la mémoire locale (application) ou externe (carte mémoire) reste affichée.
-  → **Home**
Retour direct au menu principal.





6.7 Modifier le nom de fichiers dans la mémoire locale / externe





-  → **Mémoire locale** 
ou **mémoire externe** 
Liste de tous les fichiers ou dossiers sauvegardés dans la mémoire locale (application) ou externe (carte mémoire).

-  → **Edition**
Sélectionnez le fichier () dont vous désirez modifier le nom.
-  → 
-  → **Modifier le nom**
Vous pouvez modifier le nom du fichier.
Veuillez saisir un nouveau nom, puis confirmez votre saisie à l'aide de la touche **OK** ()
-  → **Terminé**
La liste de tous les fichiers et dossiers sauvegardés dans la mémoire locale (application) ou externe (carte mémoire) reste affichée.
-  → **Home**
Retour direct au menu principal.





6.8 Création d'un nouveau dossier dans la mémoire locale / externe

-  → **Mémoire locale** 
ou **mémoire externe** 
Liste de tous les fichiers ou dossiers sauvegardés dans la mémoire locale (application) ou externe (carte mémoire).
-  → 

-  → **Nouveau dossier**
Un nouveau dossier sera créé. Veuillez saisir le nom du dossier, puis confirmez votre saisie à l'aide de la touche **OK** ()
-  → **Home**
Retour direct au menu principal.

6.9 Création de documents texte dans la mémoire locale / externe

-  → **Mémoire locale** 
ou **mémoire externe** 
Liste de tous les fichiers ou dossiers sauvegardés dans la mémoire locale (application) ou externe (carte mémoire).





-  → **+**
-  → **Nouveau document texte**
Un nouveau document sera créé. Saisissez le texte.
-  → **Sauvegarde**
Saisissez un nom de fichier pour le document texte, puis confirmez votre saisie à l'aide de la touche **OK** () . Le document texte sera sauvegardé.
-  → **Interruption**
La liste de tous les fichiers et dossiers sauvegardés dans la mémoire locale (application) ou externe (carte mémoire) reste affichée.

-  → **Home**
Retour direct au menu principal.

6.10 Informations concernant la mémoire locale et externe

-  →  **Mémoire locale** 
ou **mémoire externe** 
La capacité de stockage maximale et la capacité de stockage encore disponible de la mémoire concernée apparaissent à l'écran.

6.11 Application paramètres

-  → **Paramètres** 
Accès aux paramètres de l'application **MoveData** de Hama.
-  → **Via**
Informations détaillées concernant le logiciel (version, éditeur de l'application, etc.)
-  → **Affichage des fichiers masqués**
Sélectionnez cette option afin d'afficher les fichiers masquée ou cachés via l'application.

-
-  → **Modification de l'extension du fichier**
Sélectionnez cette option afin d'afficher les extensions de fichiers et de les modifier (à l'aide de la fonction "Modification" de 6.7. Modifier le nom de fichiers dans la mémoire locale / externe).



Avertissement concernant les extensions de fichiers

La modification d'une extension de fichier est susceptible de rendre le fichier inutilisable.

7. Exclusion de garantie

La société Hama GmbH & Co. KG décline toute responsabilité en cas de dommages provoqués par une installation, un montage ou une utilisation non conformes du produit ou encore provoqués par un non respect des consignes du mode d'emploi et/ou des consignes de sécurité.

8. Service et assistance

En cas de question concernant le produit, veuillez vous adresser au service de conseil produits de Hama.

Ligne téléphonique directe : +49 9091 502-115 (allemand/anglais)

Vous trouverez ici de plus amples informations concernant l'assistance : www.hama.com

E Instrucciones de uso

Le agradecemos que se haya decidido por un producto de Hama. Tómese tiempo y léase primero las siguientes instrucciones e indicaciones. Después, guarde estas instrucciones de manejo en un lugar seguro para poder consultarlas cuando sea necesario. Si vende el aparato, entregue estas instrucciones de manejo al nuevo propietario.

1. Explicación de los símbolos de aviso y de las indicaciones



Aviso

Se utiliza para caracterizar las indicaciones de seguridad o para llamar la atención sobre peligros y riesgos especiales.



Nota

Se utiliza para caracterizar informaciones adicionales o indicaciones importantes.

2. Contenido del paquete

- Lector de tarjetas Lightning-USB „MoveData“
- Estas instrucciones de manejo

3. Instrucciones de seguridad

- El producto es para el uso doméstico privado, no comercial.
- Proteja el producto de la suciedad, la humedad y el sobrecalentamiento y utilícelo sólo en recintos secos.
- No opere el producto en las inmediaciones de la calefacción, de otras fuentes de calor o bajo la radiación directa del sol.
- No deje caer el producto ni lo someta a sacudidas fuertes.
- No intente mantener o reparar el aparato por cuenta propia. Encomiende cualquier trabajo de mantenimiento al personal especializado competente.
- No abra el producto y no lo siga operando de presentar deterioros.
- Deseche el material de embalaje en conformidad con las disposiciones locales sobre el desecho vigentes.
- No realice cambios en el aparato. Esto conllevaría la pérdida de todos los derechos de la garantía.
- Este aparato, como todos los aparatos eléctricos, no debe estar en manos de los niños.

4. Datos técnicos



Aviso

No utilice nunca el conector USB tipo A y el conector Lightning al mismo tiempo.



Lector de tarjetas Lightning-USB „MoveData“

Alimentación de corriente 5V $\overline{=}$ máx. 500 mA

Tarjeta de memoria microSD/ microSDHC/ microSDXC

Conexiones

USB 2.0 tipo A
Lightning (conexión de 8 pines)

Sistemas operativos:

- Windows 10/8/7/Vista/XP
- Mac OS 9.x o versiones más recientes
- Mac iOS 5.1 o versiones más recientes
- Condición: Instalación de la app de Hama **MoveData**

5. Utilización mediante conexión USB

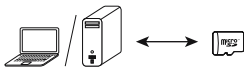

- Introduzca la tarjeta de memoria en la ranura correspondiente del lector de tarjetas.
- Presione el desbloqueo y deslícelo en dirección a la conexión que desee (USB). Conecte el lector de tarjetas a un puerto USB libre de su ordenador.
- Ahora puede proceder con la transmisión de datos entre su ordenador y la tarjeta de memoria.



Advertencia – Pérdida de datos

- Antes de retirar una tarjeta de memoria del lector de tarjetas, asegúrese de que la transmisión de datos ha finalizado.
- Siempre que desee retirar el medio extraíble de almacenamiento de datos, utilice la función de expulsión de su sistema operativo antes de desconectar el medio de memoria del lector de tarjetas o el lector de tarjetas (con el medio de memoria) del terminal.

6. Utilización mediante la conexión Lightning



Nota – Tarjetas de memoria microSD/ microSDHC/ microSDXC

- Para poder utilizar sin problemas la tarjeta instalada, es necesario formatearla al formato de archivos FAT32.
- Para que la transmisión de sus datos/archivos sea óptima, se recomienda el uso de tarjetas de memoria a partir de Class10.
- Descargue la app de Hama **MoveData** de Apple App Store.
- Introduzca la tarjeta de memoria en la ranura correspondiente del lector de tarjetas.
- Presione el desbloqueo y deslícelo en dirección a la conexión que desee (Lightning).
- Conecte el lector de tarjetas con ayuda de la conexión Lightning a su terminal (iPhone/iPad/iPod).
- Abra la app **MoveData**.

En el menú principal dispone de distintos menús para el uso del lector de tarjetas.



Salvar contactos

- Guardar los datos de contactos del terminal en la tarjeta de memoria
- Restablecer los datos de contactos de la tarjeta de memoria en un terminal



Memoria local

- Capacidad de memoria para archivos directamente en la app de Hama **MoveData**
- Ventaja: Acceso directo a los archivos guardados aquí, también sin lector de tarjetas



Memoria externa

- Acceso directo a los archivos de la tarjeta de memoria (sólo cuando se utiliza el lector de tarjetas)



Álbum de fotos

- Acceso directo a los archivos (fotos, vídeos) del terminal



Ajustes

- Acceso a los ajustes de la app de Hama **MoveData**



Nota – Autorización para la app

- La app de Hama **MoveData** necesita para algunas funciones la autorización para el acceso a su terminal (p. ej., guardar/restablecer datos de contactos, guardar fotos, etc.)
- Si la app no cuenta con tal autorización, recibirá el mensaje correspondiente cuando intente ejecutar esas funciones.
- Para permitir el acceso, seleccione la app de Hama **MoveData** en los ajustes de su terminal y desplace el regulador correspondiente a la posición verde.



Nota – Símbolo



Este símbolo se utiliza cuando usted debe tocar un punto determinado de la pantalla para ejecutar un acción o abrir un menú.

6.1 Guardar / restablecer datos de contactos

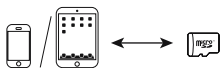

Advertencia – Pérdida de datos al restablecer los datos de los contactos

Cuando se restablecen datos de contactos de la tarjeta de memoria en el terminal, los datos de contactos que ya están guardados en el terminal se borran. Después de restablecer, sólo dispondrá de los datos de contactos del archivo de copia de seguridad.

•  → **Salvar contactos** 

•  → **Guardar** 

Todos los datos de contactos del terminal se guardan en la tarjeta de memoria del lector de tarjetas (en formato .vcf).

•  → **Restablecer** 

Acceso a todos los datos de contactos que están guardados en la tarjeta de memoria. Seleccione el archivo () que contiene los datos de los contactos que desea para restablecerlos en el terminal.

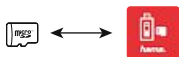

6.2 Transmisión de los datos entre la memoria local y una externa





Nota – Transmisión dentro de la misma posición de memoria

Con esta variante de transmisión se pueden transmitir también archivos y carpetas dentro de la misma posición de memoria (p. ej., mover una foto de la memoria externa a una subcarpeta de la memoria externa).



6.2.1 Archivos/carpetas individuales o múltiples

-  → **Memoria local** 
- o **Memoria externa** 

Listado de todos los archivos y carpetas guardados en la memoria local (app) o en la memoria externa (tarjeta de memoria).



-  → **Editar**
 Seleccione el(los) archivo(s) o carpeta(s) () que desea transmitir a la otra memoria.
 En la parte inferior de la pantalla aparecen tres posibilidades de selección:
Borrar: Borra el(los) archivo(s) o carpeta(s) seleccionado(s) de la memoria local o externa.
Mover: Mueve el(los) archivo(s) o carpeta(s) seleccionado(s) (Borrar simultáneamente el(los) archivo(s) o carpeta(s) seleccionado(s) de la memoria original)
Copiar: Copia el(los) archivo(s) o carpeta(s) seleccionado(s) (Recibir simultáneamente el(los) archivo(s) o carpeta(s) seleccionado(s) de la memoria original)





-  → **Copiar o Mover**

-  → **Memoria local** 
 o **Memoria externa** 

El(los) archivo(s) o carpeta(s) seleccionado(s) se guardan en la memoria local (app) o en la externa (tarjeta de memoria).

- Tiene distintas posibilidades para guardar el(los) archivo(s) o carpeta(s) seleccionado(s):







-  → **Carpeta nueva**
 Se crea una nueva carpeta. Introduzca un nombre de carpeta y confirme con **OK** ()

- Seleccione la carpeta que acaba de crear o una carpeta que ya exista ()
-  → **Pegar aquí** oder **Mover**
 El(los) archivo(s) o carpeta(s) seleccionado(s) se guardan en la carpeta leccionada o directamente en la memoria local/externa.
 El progreso de copiar o mover se indica en la pantalla.
-  → **Finalizado**
 Se completa el proceso.
-  → **Inicio**
 Acceso directo al menú principal.



6.2.2 Archivos individuales

Nota

Con esta variante de transmisión sólo se puede seleccionar y transmitir un solo archivo.



-  → **Memoria local** 
 o **Memoria externa** 
 Listado de todos los archivos y carpetas guardados en la memoria local (app) o en la memoria externa (tarjeta de memoria).
-  → **Editar**
 Seleccione el archivo () que desea transmitir a la otra memoria.
-  → 

•  → **Copiar o Mover**

•  → **Memoria local** 
o **Memoria externa** 

El archivo seleccionado se guarda en la memoria local (app) o en la externa (tarjeta de memoria).

• Tiene distintas posibilidades para guardar el archivo seleccionado:

 → **Carpeta nueva**
Se crea una nueva carpeta. Introduzca un nombre de carpeta y confirme con **OK** ().
Seleccione la carpeta que acaba de crear o una carpeta que ya exista (.

•  → **Pegar aquí o Mover**
El archivo seleccionado se guarda en la carpeta seleccionada o directamente en la memoria local/externa.
El progreso de copiar o mover se indica en la pantalla.

•  → **Finalizado**
Se completa el proceso.

•  → **Inicio**
Acceso directo al menú principal.



6.3 Transmisión de archivo de la memoria local al terminal





Nota

- Desde la memoria local (app) se pueden transmitir archivos al terminal o abrirlos/ utilizarlos con otras apps.
- Con esta forma de transmisión se pueden transmitir (individualmente) sólo archivos de imagen y de vídeo al terminal.

•  → **Memoria local** 
Listado de todos los archivos y carpetas guardados en la memoria local (app).

•  → **Editar**
Seleccione el archivo () que desea transmitir al terminal.

•  → 

•  → **Abrir**

•  → **Guardar imagen o Guardar vídeo**
La imagen o vídeo seleccionado se guarda en el terminal.

-  → **Finalizado**
Se completa el proceso.



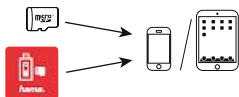

-  → **Inicio**
Acceso directo al menú principal.



6.4 Transmisión de archivo de la memoria local/externa al terminal



Nota

Con esta forma de transmisión se pueden transmitir (individualmente) sólo archivos de imagen al terminal.

-  → **Memoria local** 
o **Memoria externa** 
Listado de todos los archivos y carpetas guardados en la memoria local (app) o en la memoria externa (tarjeta de memoria).
- Seleccione la imagen () que desea transmitir al terminal.
- La imagen se visualiza.
-  → **Guardar**
La imagen seleccionada se guarda en el terminal.

-  → **Cancelar**
-  → **Inicio**
Acceso directo al menú principal.



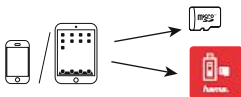

6.5 Transmisión de archivo del terminal a la memoria local/externa



6.5.1 Vía Álbum de fotos



Nota

Con esta forma de transmisión se pueden transmitir sólo archivos de imagen y de vídeo del terminal.

-  → **Álbum de fotos** 
Listado de todas las carpetas (álbumes) o archivos de medios guardados en el terminal.
- De proceder, seleccione la carpeta () en la que se encuentra(n) el(los) archivo(s) que desee.
- Seleccione el(los) archivo(s) () que desea transmitir.
-  → **Finalizado**
Se puede especificar una carpeta de destino en la que guardar el(los) archivo(s) seleccionado(s).

-  → **Memoria local** 
o **Memoria externa** 
El(los) archivo(s) seleccionado(s) se guarda(n) en la memoria local (app) o en la externa (tarjeta de memoria).

- Tiene distintas posibilidades para guardar el(los) archivo(s) seleccionado(s):

-  → **Carpeta nueva**
Se crea una nueva carpeta. Introduzca un nombre de carpeta y confirme con **OK** ().
Seleccione la carpeta que acaba de crear o una carpeta que ya exista (.



-  → **Pegar aquí**
El(los) archivo(s) o carpeta(s) seleccionado(s) se guardan en la carpeta seleccionada o directamente en la memoria local o en la externa. Completado el proceso de copia, se vuelve directamente al menú principal.

6.5.2 Vía Importar de la galería

-  → **Memoria local** 
o **Memoria externa** 
Listado de todos los archivos y carpetas guardados en la memoria local (app) o en la memoria externa (tarjeta de memoria).

-  → **+**

-  → **Importar de la galería**
Listado de todas las carpetas / archivos de medios guardados en el terminal.

- De proceder, seleccione la carpeta () en la que se encuentra(n) el(los) archivo(s) que desee.
- Seleccione el(los) archivo(s) () que desea transmitir.



-  → **Finalizado**
El(los) archivo(s) seleccionado(s) se guarda(n) directamente en la memoria local o en la externa. Usted se sigue encontrando en el listado de todos los archivos y carpetas guardados en la memoria local (app) / en la memoria externa (tarjeta de memoria).

-  → **Inicio**
Acceso directo al menú principal.

6.5.3 Vía Portapapeles





Con esta forma de transmisión se pueden transmitir (individualmente) sólo archivos de imagen del terminal.

- Seleccione en la Galería (Fotos) del terminal la imagen () que desea transmitir a la memoria local/externa. La imagen se visualiza.
-  → 

-  → **Copiar**
La imagen seleccionada se copia en el portapapeles del terminal.

• Abra la app de Hama **MoveData**.

-  → **Memoria local** 
o **Memoria externa** 

Listado de todos los archivos y carpetas guardados en la memoria local (app) o en la memoria externa (tarjeta de memoria).

-  → **+**



-  → **Pegar desde el portapapeles**
La imagen seleccionada se guarda directamente en la memoria local / externa. Usted se sigue encontrando en el listado de todos los archivos y carpetas guardados en la memoria local (app) / en la memoria externa (tarjeta de memoria).

-  → **Inicio**
Acceso directo al menú principal.







6.6 Borrar archivos/carpetas de la memoria local/externa





6.6.1 Archivos/carpetas múltiples

-  → **Memoria local** 
o **Memoria externa** 









Listado de todos los archivos y carpetas guardados en la memoria local (app) o en la memoria externa (tarjeta de memoria).

-  → **Editar**
Seleccione el(los) archivo(s)/carpetas () que desea borrar.
-  → **Borrar**
Confirme el proceso de borrado (). El(los) archivo(s) seleccionado(s) se borra(n) de la memoria local/externa.
-  → **Finalizado**
Usted se sigue encontrando en el listado de todos los archivos y carpetas guardados en la memoria local (app)/ externa (tarjeta de memoria).
-  → **Inicio**
Acceso directo al menú principal.

6.6.2 Archivos individuales

-  → **Memoria local** 
o **Memoria externa** 









Listado de todos los archivos y carpetas guardados en la memoria local (app) o en la memoria externa (tarjeta de memoria).

-  → **Editar**
Seleccione el archivo/carpeta () que desea borrar.
-  → 
-  → **Borrar**
Confirme el proceso de borrado ().
El archivo/carpeta seleccionado(a) se borra de la memoria local/externa.
-  → **Finalizado**
Usted se sigue encontrando en el listado de todos los archivos y carpetas guardados en la memoria local (app)/ externa (tarjeta de memoria).
-  → **Inicio**
Acceso directo al menú principal.

6.7 Renombrar archivos de la memoria local/externa





-  → **Memoria local** 
o **Memoria externa** 
- Listado de todos los archivos y carpetas guardados en la memoria local (app) o en la memoria externa (tarjeta de memoria).

-  → **Editar**
Seleccione el(los) archivo(s) () que desea renombrar.
-  → 
-  → **Renombrar**
El archivo se puede renombrar. Introduzca un nombre nuevo y confirme con **OK** ()
-  → **Finalizado**
Usted se sigue encontrando en el listado de todos los archivos y carpetas guardados en la memoria local (app) / en la memoria externa (tarjeta de memoria).
-  → **Inicio**
Acceso directo al menú principal.





6.8 Crear una carpeta nueva en la memoria local/externa

-  → **Memoria local** 
o **Memoria externa** 
- Listado de todos los archivos y carpetas guardados en la memoria local (app) o en la memoria externa (tarjeta de memoria).
-  → 

-  → **Carpeta nueva**
Se crea una nueva carpeta. Introduzca un nombre de carpeta y confirme con **OK** ().
-  → **Inicio**
Acceso directo al menú principal.

6.9 Crear documentos de texto en la memoria local/externa

-  → **Memoria local** 
o **Memoria externa** 
Listado de todos los archivos y carpetas guardados en la memoria local (app) o en la memoria externa (tarjeta de memoria).





-  → **+**
-  → **Nuevo documento de texto**
Se crea un nuevo documento de texto. Introduzca el texto que desee.
-  → **Guardar**
Introduzca un nombre de archivo para el documento de texto y confirme con **OK** (). El documento de texto se ha guardado.
-  → **Cancelar**
Usted se sigue encontrando en el listado de todos los archivos y carpetas guardados en la memoria local (app) / en la memoria externa (tarjeta de memoria).

-  → **Inicio**
Acceso directo al menú principal.

6.10 Informaciones sobre la memoria externa y la local

-  →  **En Memoria local** 
o **Memoria externa** 
Se le indican el espacio de memoria máximo y el espacio disponible de la memoria correspondiente.

6.11 Ajustes de la app

-  → **Ajustest** 
Acceso a los ajustes de la app de Hama **MoveData**.
-  → **Acerca de**
Información detallada sobre el software (versión, editor de la app, etc.)
-  → **Mostrar archivos ocultos**
Cuando se activa esta opción se visualizan los archivos ocultos en la app.

-
-  → **Modificar extensión de archivo**
Cuando se activa esta opción, las extensiones de los archivos se hacen visibles y se pueden editar (con ayuda de la función Renombrar de 6.7. Renombrar archivos de la memoria local/externa).



Advertencia – Modificar extensiones de archivos

En algunos casos, la modificación de las extensiones de los archivos los puede dejar inservibles.

7. Exclusión de responsabilidad

Hama GmbH & Co KG no se responsabiliza ni concede garantía por los daños que surjan por una instalación, montaje o manejo incorrectos del producto o por la no observación de las instrucciones de manejo y/o de las instrucciones de seguridad.

8. Servicio y soporte

Si tiene que hacer alguna consulta sobre el producto, diríjase al asesoramiento de productos Hama.

Línea directa: +49 9091 502-115 (Alemán/Inglés)

Encontrar más información de soporte aquí:

www.hama.com

D Hinweis zum Umweltschutz:



Ab dem Zeitpunkt der Umsetzung der europäischen Richtlinien 2002/96/EG und 2006/66/EG in nationales Recht gilt folgendes:

Elektrische und elektronische Geräte sowie Batterien dürfen nicht mit dem Hausmüll entsorgt werden. Der Verbraucher ist gesetzlich verpflichtet, elektrische und elektronische Geräte sowie Batterien am Ende ihrer Lebensdauer an den dafür eingerichteten, öffentlichen Sammelstellen oder an die Verkaufsstelle zurückzugeben. Einzelheiten dazu regelt das jeweilige Landesrecht. Das Symbol auf dem Produkt, der Gebrauchsanleitung oder der Verpackung weist auf diese Bestimmungen hin. Mit der Wiederverwertung, der stofflichen Verwertung oder anderen Formen der Verwertung von Altgeräten/Batterien leisten Sie einen wichtigen Beitrag zum Schutz unserer Umwelt.

GB Note on environmental protection:



After the implementation of the European Directive 2002/96/EU and 2006/66/EU in the national legal system, the following applies:

Electric and electronic devices as well as batteries must not be disposed of with household waste. Consumers are obliged by law to return electrical and electronic devices as well as batteries at the end of their service lives to the public collecting points set up for this purpose or point of sale. Details to this are defined by the national law of the respective country.

This symbol on the product, the instruction manual or the package indicates that a product is subject to these regulations.

By recycling, reusing the materials or other forms of utilising old devices/Batteries, you are making an important contribution to protecting our environment.

F Remarques concernant la protection de l'environnement:



Conformément à la directive européenne 2002/96/CE et 2006/66/CE, et afin d'atteindre un certain nombre d'objectifs en matière de protection de l'environnement, les règles suivantes doivent être appliquées: Les appareils électriques et électroniques ainsi que les batteries ne doivent pas être éliminés avec les déchets ménagers. Le pictogramme "picto" présent sur le produit, son manuel d'utilisation ou son emballage indique que le produit est soumis à cette réglementation. Le consommateur doit retourner le produit/la batterie usager aux points de collecte prévus à cet effet. Il peut aussi le remettre à un revendeur. En permettant enfin le recyclage des produits ainsi que les batteries, le consommateur contribuera à la protection de notre environnement. C'est un acte écologique.

E Nota sobre la protección medioambiental:



Después de la puesta en marcha de la directiva Europea 2002/96/EU y 2006/66/EU en el sistema legislativo nacional, se aplicara lo siguiente:

Los aparatos eléctricos y electrónicos, así como las baterías, no se deben evacuar en la basura doméstica.

El usuario está legalmente obligado a llevar los aparatos eléctricos y electrónicos, así como pilas y pilas recargables, al final de su vida útil a los puntos de recogida comunales o a devolverlos al lugar donde los adquirió. Los detalles quedaran definidos por la ley de cada país. El símbolo en el producto, en las instrucciones de uso o en el embalaje hace referencia a ello. Gracias al reciclaje, al reciclaje del material o a otras formas de reciclaje de aparatos/pilas usados, contribuye Usted de forma importante a la protección de nuestro medio ambiente.

NL Notitie aangaande de bescherming van het milieu:



Ten gevolge van de invoering van de Europese Richtlijn 2002/96/EU en 2006/66/EU in het nationaal juridisch systeem, is het volgende van toepassing:

Elektrische en elektronische apparatuur, zoals batterijen mag niet met het huisvuil weggegooid worden. Consumenten zijn wettelijk verplicht om elektrische en elektronische apparaten zoals batterijen op het einde van gebruik in te dienen bij openbare verzamelplaatsen speciaal opgezet voor dit doelinde of bij een verkooppunt. Verdere specificaties aangaande dit onderwerp zijn omschreven door de nationale wet van het betreffende land. Dit symbool op het product, de gebruiksaanwijzing of de verpakking duidt erop dat het product onderworpen is aan deze richtlijnen. Door te recyclen, hergebruiken van materialen of andere vormen van hergebruiken van oude toestellen/batterijen, levert u een grote bijdrage aan de bescherming van het milieu.

I Informazioni per protezione ambientale:



Dopo l'implementazione della Direttiva Europea 2002/96/EU e 2006/66/EU nel sistema legale nazionale, ci sono le seguenti applicazioni:

Le apparecchiature elettriche ed elettroniche e le batterie non devono essere smaltite con i rifiuti domestici. I consumatori sono obbligati dalla legge a restituire i dispositivi elettrici ed elettronici e le batterie alla fine della loro vita utile ai punti di raccolta pubblici preposti per questo scopo o nei punti vendita. Dettagli di quanto riportato sono definiti dalle leggi nazionali di ogni stato. Questo simbolo sul prodotto, sul manuale d'istruzioni o sull'imballo indicano che questo prodotto è soggetto a queste regole. Riciclando, ri-utilizzando i materiali o utilizzando sotto altra forma i vecchi prodotti/le batterie, darete un importante contributo alla protezione dell'ambiente.

GR Υπόδειξη σχετικά με την προστασία περιβάλλοντος:



Από τη στιγμή που η Ευρωπαϊκή Οδηγία 2002/96/ΕΕ και 2006/66/ΕΕ ενσωματώνεται στο εθνικό δίκαιο ισχύουν τα εξής:

Οι ηλεκτρικές και οι ηλεκτρονικές συσκευές καθώς και οι μπαταρίες δεν επιτρέπεται να πετιούνται στα οικιακά απορρίμματα. Οι καταναλωτές υποχρεούνται από τον νόμο να επιστρέφουν τις ηλεκτρικές και ηλεκτρονικές συσκευές καθώς και τις μπαταρίες στο τέλος της ζωής τους στα δημόσια σημεία περισυλλογής που έχουν δημιουργηθεί γι' αυτό το σκοπό ή στα σημεία πώλησης. Οι λεπτομέρειες ρυθμίζονται στη σχετική νομοθεσία. Το σύμβολο πάνω στο προϊόν, στο εγχειρίδιο χρήσης ή στη συσκευασία παραπέμπει σε αυτές τις διατάξεις. Με την ανακύκλωση, επαναχρησιμοποίηση των υλικών ή με άλλες μορφές χρησιμοποίησης παλιών συσκευών / Μπαταριών συνεισφέρει σημαντικά στην προστασία του περιβάλλοντος. Στη Γερμανία ισχύουν αντίστοιχα οι παραπάνω κανόνες απόρριψης σύμφωνα με τον κανονισμό για μπαταρίες και συσσωρευτές.

S Not om miljöskydd:



Efter implementeringen av EU direktiv 2002/96/EU och 2006/66/EU i den nationella lagstiftningen, gäller följande:

Elektriska och elektroniska apparater samt batterier får inte kastas i hushållssoporna. Konsumenter är skyldiga att återlämna elektriska och elektroniska apparater samt batterier vid slutet av dess livslängd till, för detta ändamål, offentliga uppsamlingsplatser. Detaljer för detta definieras via den nationella lagstiftningen i respektive land. Denna symbol på produkten, instruktionsmanualen eller på förpackningen indikerar att produkten innefattas av denna bestämmelse. Genom återvinning och återanvändning av material/batterier bidrar du till att skydda miljön och din omgivning.

FIN Ympäristönsuojelua koskeva ohje:



Siitä lähtien, kun Euroopan unionin direktiivi 2002/96/EU ja 2006/66/EU otetaan käyttöön kansallisessa lainsäädännössä, pätevät seuraavat määräykset:

Sähkö- ja elektroniikkalaitteita ja paristoja ei saa hävittää talousjätteen mukana. Kuluttajalla on lain mukaan velvollisuus toimittaa sähkö- ja elektroniikkalaitteet niiden käyttöiän päätyttyä niille varattuun julkisiin keräyspisteisiin tai palauttaa ne myyntipaikkaan. Tähän liittyvistä yksityiskohdista säädetään kulloisenkin osavaltion laissa. Näistä määräyksistä mainitaan myös tuotteen symbolissa, käyttöohjeessa tai pakkauksessa. Uudelleenkäytöllä, materiaalien/paristojen uudelleenkäytöllä tai muilla vanhojen laitteiden uudelleenkäyttötavoilla on tärkeä vaikutus yhteisen ympäristömme suojelussa.

PL Wskazówki dotyczące ochrony środowiska:



Od czasu wprowadzenia europejskiej dyrektywy 2002/96/EU i 2006/66/EU do prawa narodowego obowiązują następujące ustalenia:

Urządzeń elektrycznych, elektronicznych oraz baterii jednorazowych nie należy wyrzucać razem z codziennymi odpadami domowymi! Użytkownik zobowiązany prawnie do odniesienia zepsutych, zniszczonych lub niepotrzebnych urządzeń elektrycznych i elektronicznych do punktu zbiórki lub do sprzedawcy. Szczegółowe kwestie regulują przepisy prawne danego kraju. Informuje o tym symbol przekreślonego kosza umieszczony na opakowaniu. Segregując odpady pomagasz chronić środowisko!

H Környezetvédelmi tudnivalók:



Az európai irányelvek 2002/96/EU és 2006/66/EU ajánlása szerint, a megjelölt időponttól kezdve, minden EU-s tagállamban érvényesek a következők:

Az elektromos és elektronikai készülékeket és az elemeket nem szabad a háztartási szemétkébe dobni! A leselejtezett elektromos és elektronikus készülékeket és elemeket, akkumulátorokat nem szabad a háztartási szemétkébe dobni. Az elhasznált és működésképtelen elektromos és elektronikus készülékek gyűjtésére törvényi előírás kötelez mindenkit, ezért azokat el kell szállítani egy kijelölt gyűjtő helyre vagy visszavinni a vásárlás helyére. A termék csomagolásán feltüntetett szimbólum egyértelmű jelzést ad erre vonatkozóan a felhasználónak. A régi készülékek begyűjtése, visszaváltása vagy bármilyen formában történő újra hasznosítása közös hozzájárulás környezetünk védelméhez.

CZ Ochrana životního prostředí:



Evropská směrnice 2002/96/EG a 2006/66/EU ustanovujete následující:

Elektrická a elektronická zařízení stejně jako baterie nepatří do domovního odpadu. Spotřebitel se zavazuje odevzdat všechna zařízení a baterie po uplynutí jejich životnosti do příslušných sběrů. Podrobnosti stanoví zákon příslušné země. Symbol na produktu, návod k obsluze nebo balení na toto poukazuje.

Recyklací a jinými způsoby užitkování přispíváte k ochraně životního prostředí.

SK Ochrana životného prostredia:



Európska smernica 2002/96/EU a 2006/66/EU stanovuje:

Elektrické a elektronické zariadenia, rovnako ako batérie sa nesmú vyhadzovať do domáceho odpadu.

Spotrebiteľ je zo zákona povinný zlikvidovať elektrické a elektronické zariadenia, rovnako ako batérie na miesta k tomu určené. Symbolizuje to obrázok v návode na použitie, alebo na balení výrobku. Opätovným zúžitkovaním alebo inou formou recyklácie starých zariadení/batérií prispievate k ochrane životného prostredia.

P Nota em Protecção Ambiental:



Após a implementação da directiva comunitária 2002/96/EU e 2006/66/EU no sistema legal nacional, o seguinte aplica-se:

Os aparelhos eléctricos e electrónicos, bem como baterias, não podem ser eliminados juntamente com o lixo doméstico. Consumidores estão obrigados por lei a colocar os aparelhos eléctricos e electrónicos, bem como baterias, sem uso em locais públicos específicos para este efeito ou no ponto de venda. Os detalhes para este processo são definidos por lei pelos respectivos países. Este símbolo no produto, o manual de instruções ou a embalagem indicam que o produto está sujeito a estes regulamentos. Reciclando, reutilizando os materiais dos seus velhos aparelhos/baterias, esta a fazer uma enorme contribuição para a protecção do ambiente.

RUS Охрана окружающей среды:



С момента перехода национального законодательства на европейские нормы 2002/96/EU и 2006/66/EU действительно следующее:

Электрические и электронные приборы, а также батареи запрещается утилизировать с обычным мусором. Потребитель, согласно закону, обязан утилизировать электрические и электронные приборы, а также батареи и аккумуляторы после их использования в специально предназначенных для этого пунктах сбора, либо в пунктах продажи. Детальная регламентация этих требований осуществляется соответствующим местным законодательством. Необходимость соблюдения данных предписаний обозначается особым значком на изделии, инструкции по эксплуатации или упаковке. При переработке, повторном использовании материалов или при другой форме утилизации бывших в употреблении приборов Вы помогаете охране окружающей среды. В соответствии с предписаниями по обращению с батареями, в Германии вышеназванные нормы действуют для утилизации батарей и аккумуляторов.

TR Çevre koruma uyarısı:



Avrupa Birliği Direktifi 2002/96/EU ve 2006/66/EU ulusal yasal uygulamalar için de geçerli olduğu tarihten itibaren:

Elektrikli ve elektronik cihazlarla piller normal evsel çöpe atılmamalıdır. Tüketiciler için, artık çalışmayan elektrikli ve elektronik cihazları piller, kamuya ait toplama yerlerine götürme veya satın alındıkları yerlere geri verme yasal bir zorunluluktur. Bu konu ile ilgili ayrıntırlar ulusal yasalarla düzenlenmektedir. Ürün üzerinde, kullanma kılavuzunda veya ambalajda bulunan bu sembol tüketiciciyi bu konuda uyandır. Eski cihazların geri kazanımı, yapıldıkları malzemelerin değerlendirilmesi veya diğer değerlendirme şekilleri ile, çevre korumasına önemli bir katkıda bulunursunuz. Yukarıda adı geçen atık toplama kuralları Almanya'da piller ve aküler için de geçerlidir.

RO Instrucțiuni pentru protecția mediului înconjurător:



Din momentul aplicării directivelor europene 2002/96/UE în dreptul național sunt valabile următoarele: Aparatele electrice și electronice nu pot fi salubrizate cu gunoiul menajer. Consumatorul este obligat conform legii să predea aparatele electrice și electronice la sfârșitul duratei de utilizare la locurile de colectare publice sau înăpoi de unde au fost cumpărate.

Detaliile sunt reglementate de către legislația țării respective. Simbolul de pe produs, în instrucțiunile de utilizare sau pe ambalaj indică aceste reglementări. Prin reciclarea, revalorificarea materialelor sau alte forme de valorificare a aparatelor scoase din uz aduceți o contribuție importantă la protecția mediului nostru înconjurător.

DK Anvisninger til beskyttelse af miljøet:



Fra og med indførelsen af EU-direktiverne 2002/96/EF og 2006/66/EF i national ret gælder følgende: Elektrisk og elektronisk udstyr samt batterier må ikke bortskaffes sammen med almindeligt husholdningsaffald. Forbrugeren er lovmæssigt forpligtet til at aflevere udtjent elektrisk og elektronisk udstyr samt batterier til dertil indrettede, offentlige indsamlingssteder eller til forhandleren. De nærmere bestemmelser vedr. dette fastlægges af lovgivningen i det pågældende land. Symbolet på produktet, brugsvejledningen eller emballagen henviser til disse bestemmelser. Ved genbrug, genvinding eller andre former for nyttiggørelse af udtjent udstyr/batterier giver du et vigtigt bidrag til beskyttelse af miljøet.

N Informasjon om beskyttelse av miljøet:



Fra tidspunktet for omsetning av de europeiske direktivene 2002/96/EF og 2006/66/EF i nasjonal rett gjelder følgende: Elektriske og elektroniske apparater og batterier må ikke deponeres sammen med husholdningsøppet. Forbrukeren er lovmessig forpliktet til å levere elektriske og elektroniske apparater og batterier til de offentlige samlestedene eller tilbake til stedet hvor produktene ble kjøpt. Detaljer angående dette reguleres av hvert land. Symbolet på produktet, bruksanvisningen eller emballasjen henviser om disse bestemmelsene. Med resirkulering, gjenbruk av stoffer eller andre former av gjenbruk av gamle apparater/batterier bidrar du betydelig til å beskytte miljøet vårt.

hama®

**Hama GmbH & Co KG
86652 Monheim / Germany
www.hama.com**

iPhone, iPod, iPad, Lightning and Apple App Store are trademarks of Apple Inc., registered in the U.S. and other countries.

"Made for iPod", "Made for iPhone" and "Made for iPad" mean that an electronic accessory has been designed to connect specifically to iPod, iPhone and iPad respectively, and has been certified by the developer to meet Apple performance standards. Apple is not responsible for the operation of this device or its compliance with safety and regulatory standards. Please note that the use of this accessory with iPod or iPhone may effect wireless performance.

All listed brands are trademarks of the corresponding companies. Errors and omissions excepted, and subject to technical changes. Our general terms of delivery and payment are applied.

00124153_54/11.15